

## CHAPTER 9 SELF-QUIZ

(Page 725)

1. True
2. False: ~~Reduction~~ Oxidation is a process in which electrons are lost or donated by an atom or ion in a redox reaction.
3. True
4. False: The strongest oxidizing agent in a galvanic cell is above the strongest reducing agent in the redox table producing a cell potential that is ~~negative~~ positive.
5. False: The ~~cathode~~ anode of a cell is the electrode where electrons are lost or given up by the reducing agent.
6. True
7. False: The cell potential of a standard lead–nickel cell is ~~-0.39~~ +0.13 V.
8. True
9. True
10. (a)
11. (d)
12. (c)
13. (a)
14. (b)
15. (d)
16. (c)
17. (c)
18. (b)

## CHAPTER 9 REVIEW

(Page 726)

### Understanding Concepts

- (a) Oxidation is a chemical process involving a loss of electrons and an increase in oxidation number.  
(b) Reduction is a chemical process involving a gain of electrons and a decrease in oxidation number.  
(c) A redox reaction is the transfer of electrons from a reducing agent to an oxidizing agent.
- (a)  $\text{Fe}_{(\text{aq})}^{3+} + \text{e}^{-} \rightarrow \text{Fe}_{(\text{aq})}^{2+}$  (reduction)  
 $\text{Ni}_{(\text{s})} \rightarrow \text{Ni}_{(\text{aq})}^{2+} + 2 \text{e}^{-}$  (oxidation)  
(b)  $\text{Br}_{2(\text{aq})} + 2 \text{e}^{-} \rightarrow 2 \text{Br}_{(\text{aq})}^{-}$  (reduction)  
 $2 \text{I}_{(\text{aq})}^{-} \rightarrow \text{I}_{2(\text{s})} + 2 \text{e}^{-}$  (oxidation)  
(c)  $\text{Pd}_{(\text{aq})}^{2+} + 2 \text{e}^{-} \rightarrow \text{Pd}_{(\text{s})}$  (reduction)  
 $\text{Sn}_{(\text{aq})}^{2+} \rightarrow \text{Sn}_{(\text{aq})}^{4+} + 2 \text{e}^{-}$  (oxidation)
- (a) 0  
(b) -1  
(c) +1  
(d) +1  
(e) -1
- (a)  $0 \quad +3 \quad -2 \quad 0 \quad +3 \quad -2$   
 $2 \text{Al}_{(\text{s})} + \text{Fe}_2\text{O}_{3(\text{s})} \rightarrow 2 \text{Fe}_{(\text{s})} + \text{Al}_2\text{O}_{3(\text{s})}$   
 $\text{Al}_{(\text{s})}$  is oxidized,  $\text{Fe}_{(\text{s})}^{3+}$  is reduced  
(b)  $0 \quad +1 \quad +3 \quad 0$   
 $\text{In}_{(\text{s})} + 3 \text{Tl}_{(\text{aq})}^{+} \rightarrow \text{In}_{(\text{aq})}^{3+} + 3 \text{Tl}_{(\text{s})}$   
 $\text{In}_{(\text{s})}$  is oxidized,  $\text{Tl}_{(\text{aq})}^{+}$  is reduced

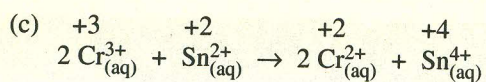

$\text{Cr}_{(aq)}^{3+}$  is reduced,  $\text{Sn}_{(aq)}^{2+}$  is oxidized

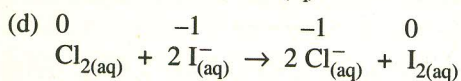

$\text{Cl}_{2(aq)}$  is reduced,  $\text{I}_{(aq)}^{-}$  is oxidized

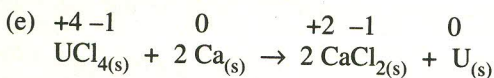

$\text{U}_{(s)}^{4+}$  is reduced,  $\text{Ca}_{(s)}$  is oxidized

5. A net ionic equation is balanced in terms of the numbers of different kinds of atoms or ions and the total electric charge on each side of the equation.

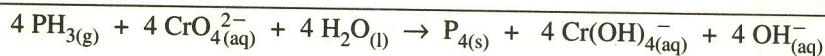
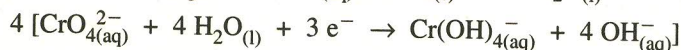
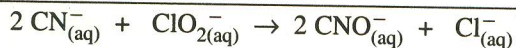
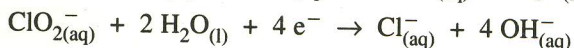
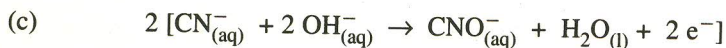
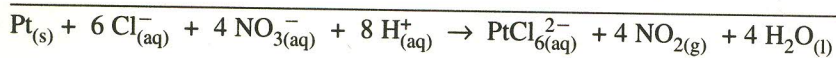
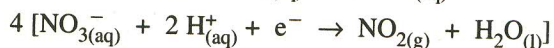
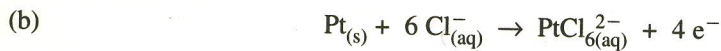
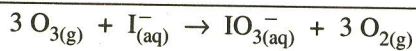
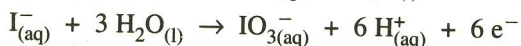
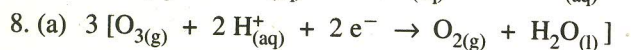
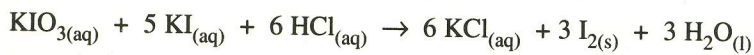
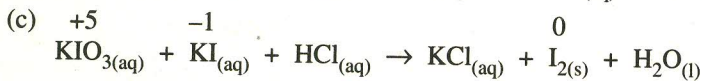
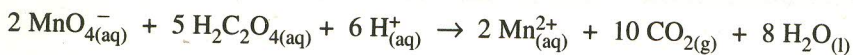
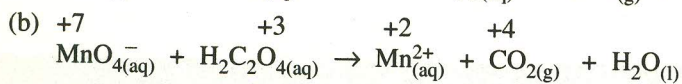
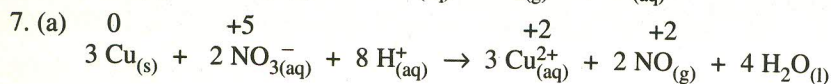
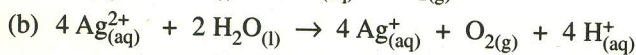
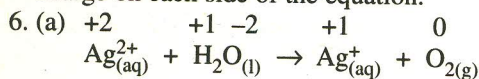

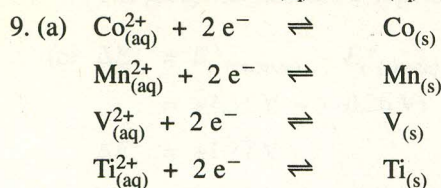
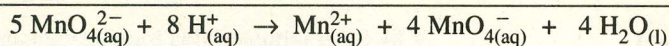
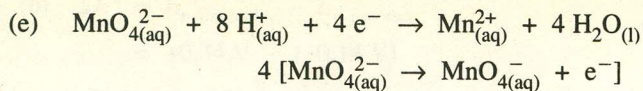

(b) In this table the strongest oxidizing agent is  $\text{Co}_{(aq)}^{2+}$  and the strongest reducing agent is  $\text{Ti}_{(s)}$ .

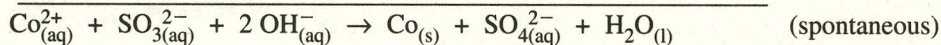
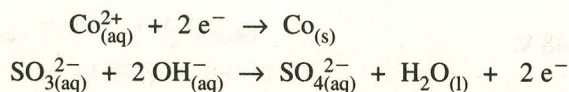
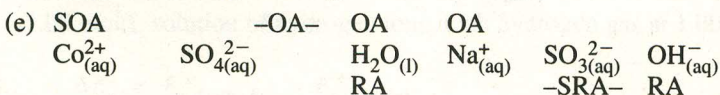
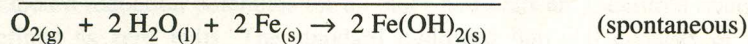
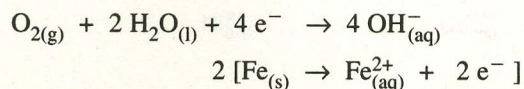
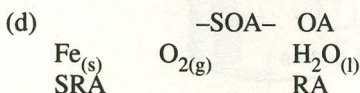
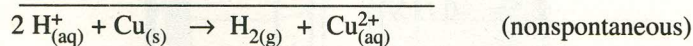
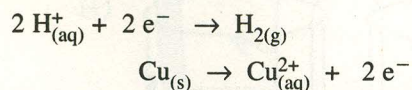
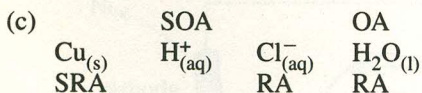
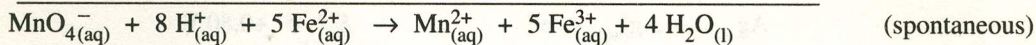
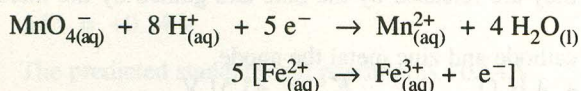
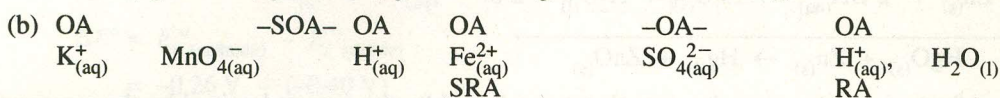
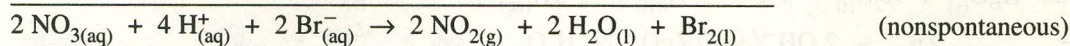
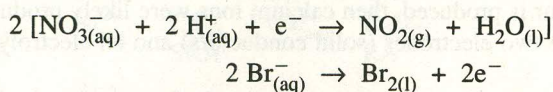
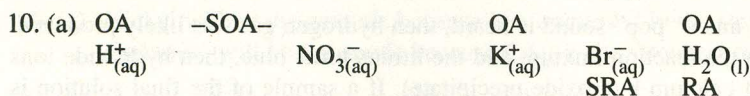

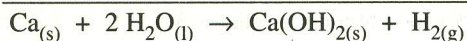
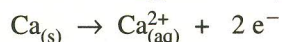
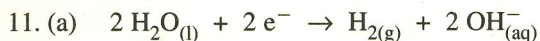
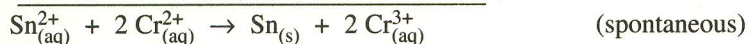
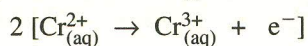
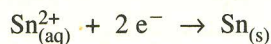
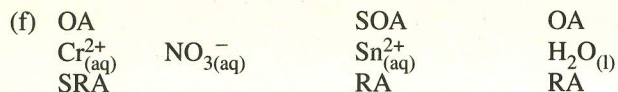

(b) If a gas is collected and exposed to a flame, and a "pop" sound is heard, then hydrogen gas was likely produced. If a piece of red litmus paper is placed into the reaction mixture and the litmus turns blue, then hydroxide ions were likely produced (slight dissociation of calcium hydroxide precipitate). If a sample of the final solution is placed into a burner flame and a yellow-red colour is produced, then calcium ions were likely produced.

12. The three essential components of an electric cell are two electrodes (solid conductors) and an electrolyte (aqueous conductor).

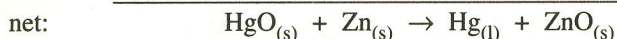
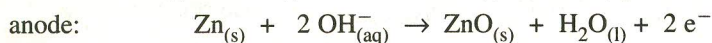
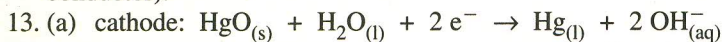

(b) The electrons flow from zinc to mercury, because they are released by the zinc and gained by the mercury(II) oxide.

(c) Mercury oxide (in a conducting paste) is likely the cathode and zinc metal the anode.

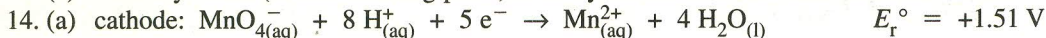

$$\begin{aligned} \Delta E^{\circ} &= E_r^{\circ}(\text{cathode}) - E_r^{\circ}(\text{anode}) \\ &= 1.51 \text{ V} - (+0.80 \text{ V}) \end{aligned}$$

$$\Delta E^{\circ} = +0.71 \text{ V}$$

The predicted cell potential is +0.71 V.

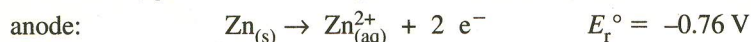
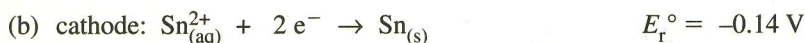

$$\begin{aligned} \Delta E^{\circ} &= E_r^{\circ}(\text{cathode}) - E_r^{\circ}(\text{anode}) \\ &= -0.14 \text{ V} - (-0.76 \text{ V}) \end{aligned}$$

$$\Delta E^{\circ} = +0.62 \text{ V}$$

The predicted cell potential is +0.62 V.

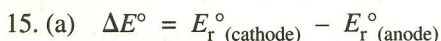

$$= -0.28 \text{ V} - (-0.76 \text{ V})$$

$$\Delta E^{\circ} = +0.48 \text{ V}$$

The predicted standard cell potential is +0.48 V.

$$\begin{aligned} \text{(b)} \quad \Delta E^\circ &= E_r^\circ(\text{cathode}) - E_r^\circ(\text{anode}) \\ &= +0.34 \text{ V} - (-0.14 \text{ V}) \end{aligned}$$

$$\Delta E^\circ = +0.48 \text{ V}$$

The predicted standard cell potential is +0.48 V.

$$\begin{aligned} \text{(c)} \quad \Delta E^\circ &= E_r^\circ(\text{cathode}) - E_r^\circ(\text{anode}) \\ &= +1.51 \text{ V} - (-0.26 \text{ V}) \end{aligned}$$

$$\Delta E^\circ = +1.77 \text{ V}$$

The predicted standard cell potential is +1.77 V.

16. (a) Nickel will be the cathode because it is immersed in the strongest oxidizing agent,  $\text{Ni}_{(\text{aq})}^{2+}$ . Cadmium will be the anode because  $\text{Cd}_{(\text{s})}$  is the strongest reducing agent.

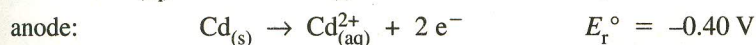
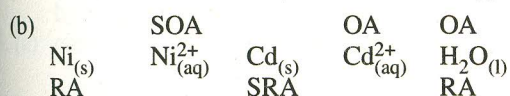

$$\begin{aligned} \Delta E^\circ &= E_r^\circ(\text{cathode}) - E_r^\circ(\text{anode}) \\ &= -0.26 \text{ V} - (-0.40 \text{ V}) \end{aligned}$$

$$\Delta E^\circ = +0.14 \text{ V}$$

The predicted standard cell potential is +0.14 V.

(c)

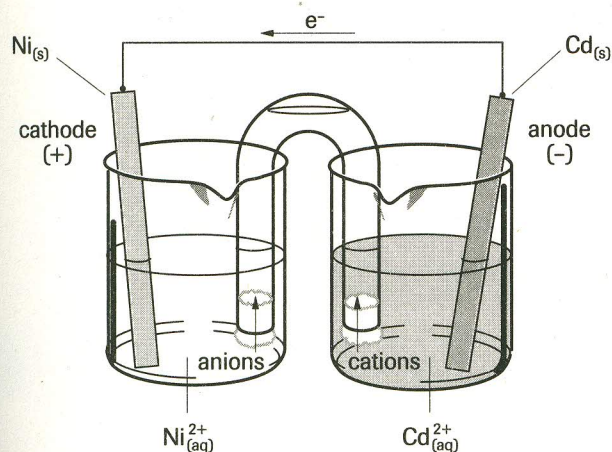

17. Standard reduction potentials for all other half-cells are measured relative to that of the standard hydrogen half-cell, defined as zero volts. The standard hydrogen half-cell consists of an inert platinum electrode immersed in a 1.00 mol/L solution of hydrogen ions, with hydrogen gas at 1.00 kPa bubbling over the electrode, and at 25°C.

$$18. \quad \Delta E^\circ = E_r^\circ(\text{cathode}) - E_r^\circ(\text{anode})$$

$$\begin{aligned} E_r^\circ(\text{cathode}) &= \Delta E^\circ + E_r^\circ(\text{anode}) \\ &= +1.94 \text{ V} + (-0.40 \text{ V}) \end{aligned}$$

$$E_r^\circ(\text{cathode}) = +1.54 \text{ V}$$

The standard reduction potential for the  $\text{Ce}_{(\text{aq})}^{3+} | \text{Ce}_{(\text{s})}$  half-cell is +1.54 V.

19. A "dead" galvanic cell has a voltage of zero and has reached an equilibrium state.
20. (a) Tin coatings adhere well to iron and provide a strong shiny coating. As long as the tin coating remains intact, the iron underneath is protected; but if the surface coating breaks, the iron beneath corrodes quickly because iron is a stronger reducing agent than tin.
- (b) Zinc coatings adhere well to iron and provide a strong coating that oxidizes to a silver-grey colour. The zinc reaction coating is basic zinc carbonate, which protects zinc and the iron underneath. If the zinc coating is broken, the zinc is preferentially oxidized compared to iron, resealing the opening and preventing the corrosion of the iron.
21. (a) The impressed current method of cathodic protection uses a battery or DC generator to supply electrons to the iron object being protected. The negative terminal of the power supply is connected to the iron object and the positive terminal is connected to an inert carbon electrode. The iron is forced to become the cathode and is protected from corroding.
- (b) The sacrificial anode method of cathodic protection uses a metal that is more easily oxidized than iron, such as zinc or magnesium. The sacrificial anode is connected to the iron object being protected, forming a galvanic cell with iron as the cathode.

### Applying Inquiry Skills

22. (a)

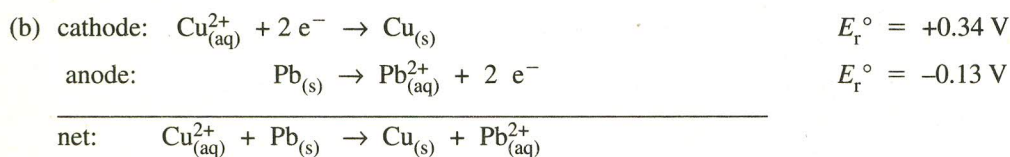
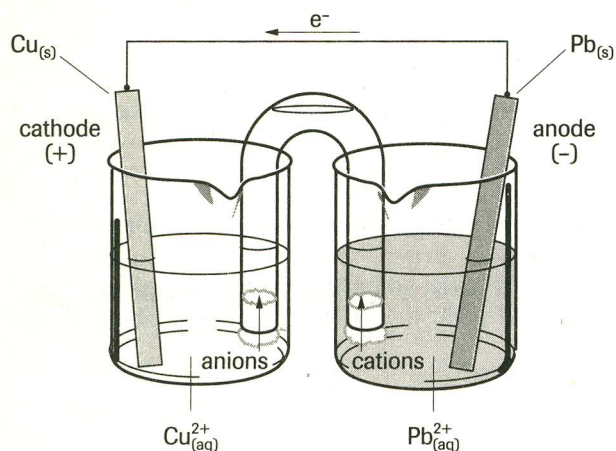

(c)  $\Delta E^\circ = E_r^\circ (\text{cathode}) - E_r^\circ (\text{anode})$   
 $= +0.34 \text{ V} - (-0.13 \text{ V})$   
 $\Delta E^\circ = +0.47 \text{ V}$

The predicted cell potential is +0.47 V.

23. (a) **Procedure**

- Clean three small strips of zinc with steel wool.
- Add a few millilitres of each unknown solution into separate, clean test tubes.
- Place a strip of zinc metal into each solution and record evidence of reaction.
- For each solution that was unreactive with zinc, add a few millilitres of each solution to separate test tubes.
- To each of these test tubes, add a few drops of sodium carbonate solution and record evidence of reaction.
- Dispose of all solutions in the waste beaker.